

# Installation Guide

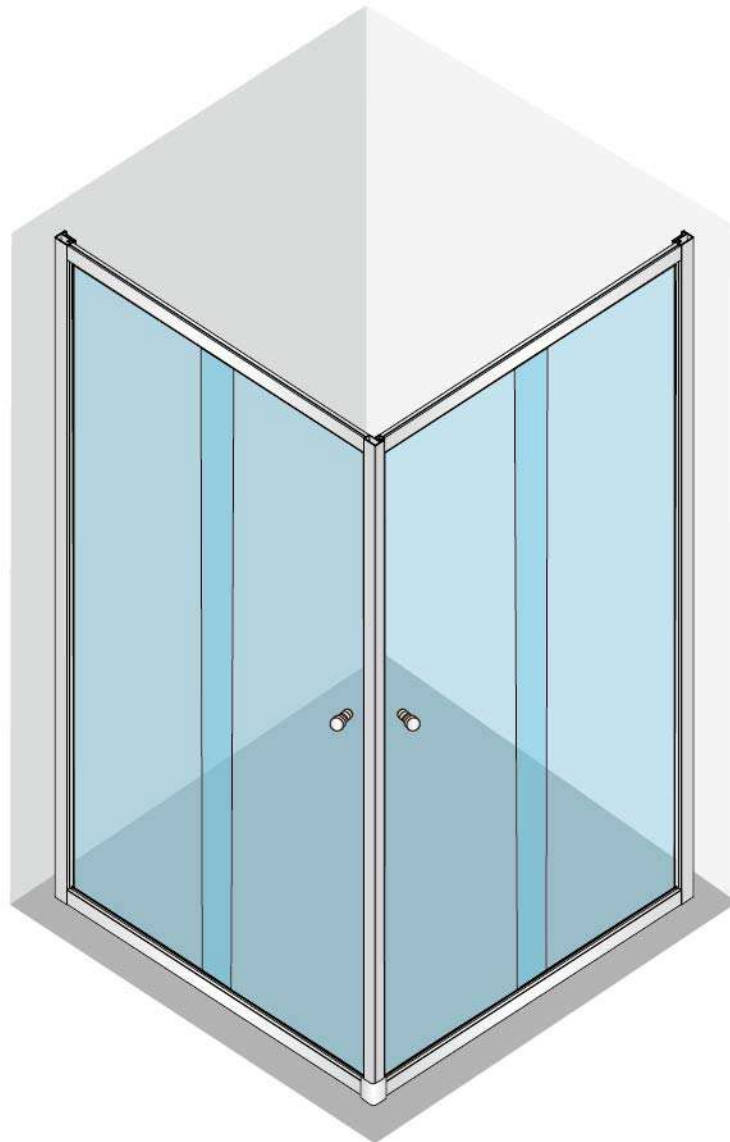

Code: V6-CES



L Shape Configuration

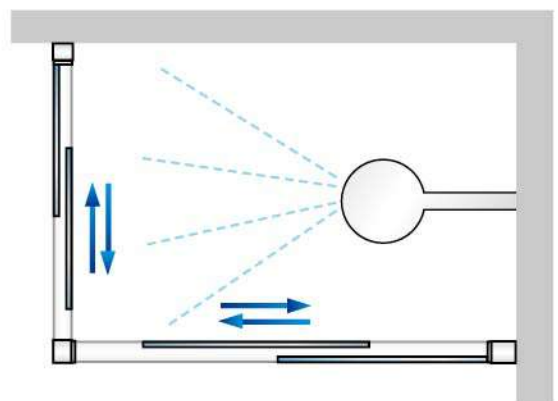
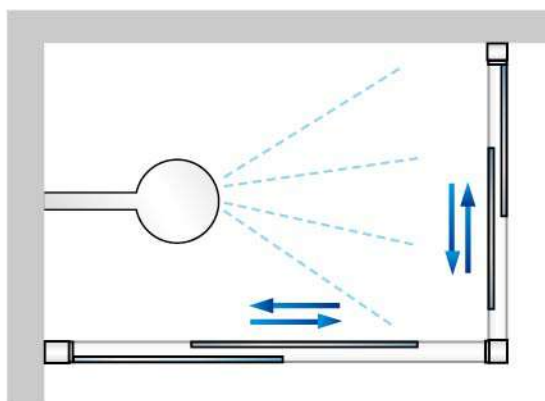

## Important Notice for Purchaser/Installers

Check the contents of the pack carefully before installation.

CONVEX will not be held responsible for any de-fit/re-fit costs where faulty product has been fitted.

If any fault is found with materials or workmanship, it must be reported immediately to the CONVEX.

Remedial action will be taken, based on information received, on condition that:

1. Full details are supplied to the CONVEX;
2. The screen has not been modified or malicious/intentional damage or neglect;
3. The CONVEX is informed of any damage/shortages prior to installation.

We do NOT accept responsibility for any problems that may occur through incorrect installation.

The success of the installation and operation of any shower screen is, of course,

dependant on the squareness, alignment and construction of the walls to which fixing is to be carried out.

## Glass Breakage Warning

CONVEX's shower glass panels are made from Grade A Toughened Safety Glass that complies with relevant Australian Standards. The glass can be damaged and broken if it is handled incorrectly, even if it is tough and hard to break. Always TWO persons install the panels with care. Toughened Safety Glass can NOT be cut, drilled or grinded like other ordinary glass.

We do NOT accept responsibility for glass breakage after dispatch from Convex.

The purchaser/installer acknowledge that it is their responsibility of checking

if the glass at the time of handover was undamaged and free from any defects.

## Safety Matters

### **ALWAYS :**

- Check there is no electrical wires or hoses before you drill or mount anything.
- Wear safety glasses and gloves when handling chemicals, silicone or such.
- Work in a safe manner & comply with OHS requirements.
- Enter the shower slowly with care to avoid slipping, open & close the shower door gently to avoid any potential damage or injury.

### **DO NOT:**

- Stand on the shower screen package or any other objects or fixings. It could cause injury or physical harm.
- Rest or place the glass panels on hard surfaces like tiles, concrete, other glass panels or metal surfaces.
- Cushion the edges with cardboard, soft timber or rubber mat.
- Impact or scratch the glass panels with any sharp metallic objects or tools.
- Allow children to use the shower alone or to play in the shower to prevent any injury.
- Use shower within 24 hours before the silicone fully dry.

## Cleaning & Maintenance



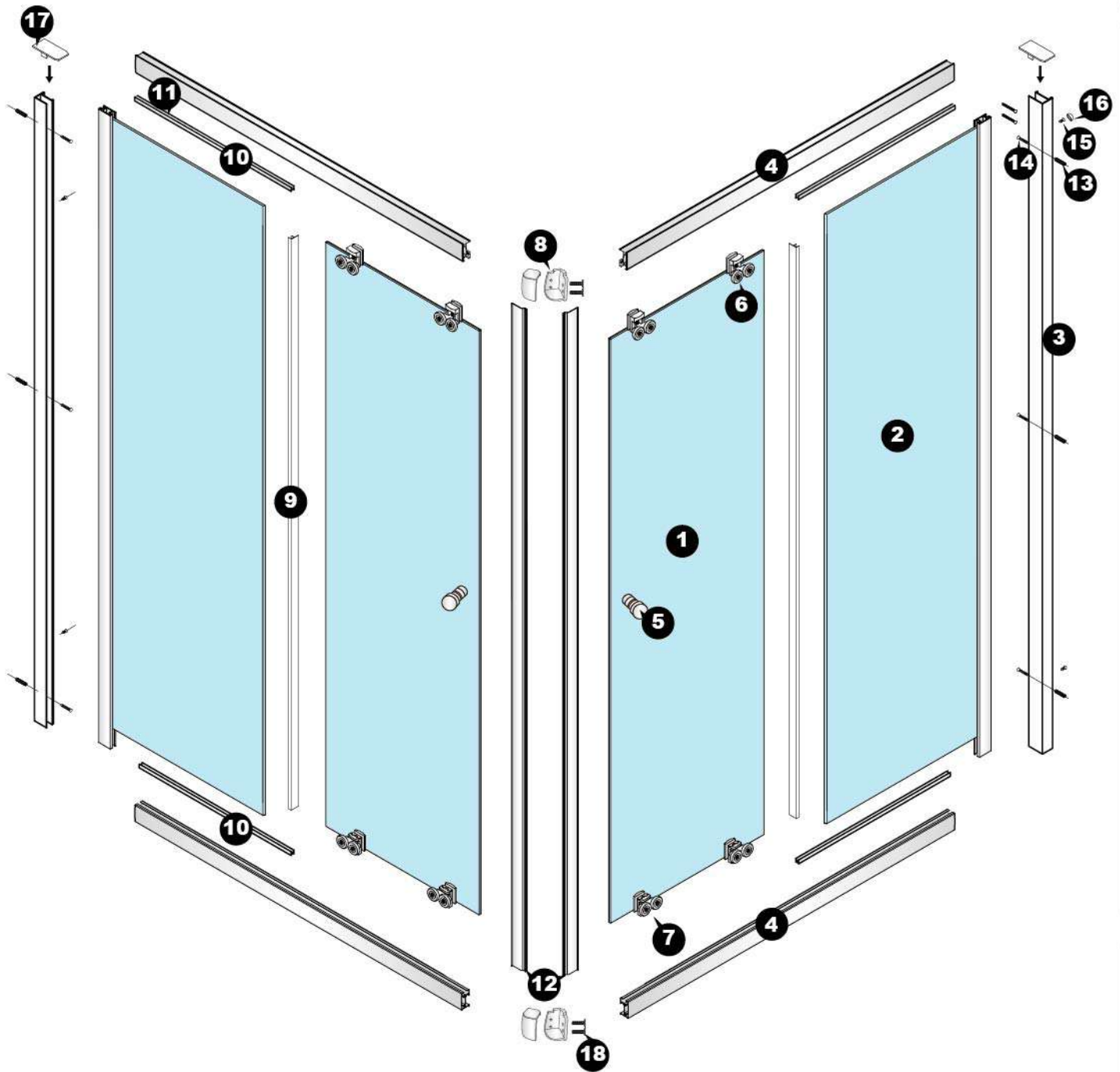



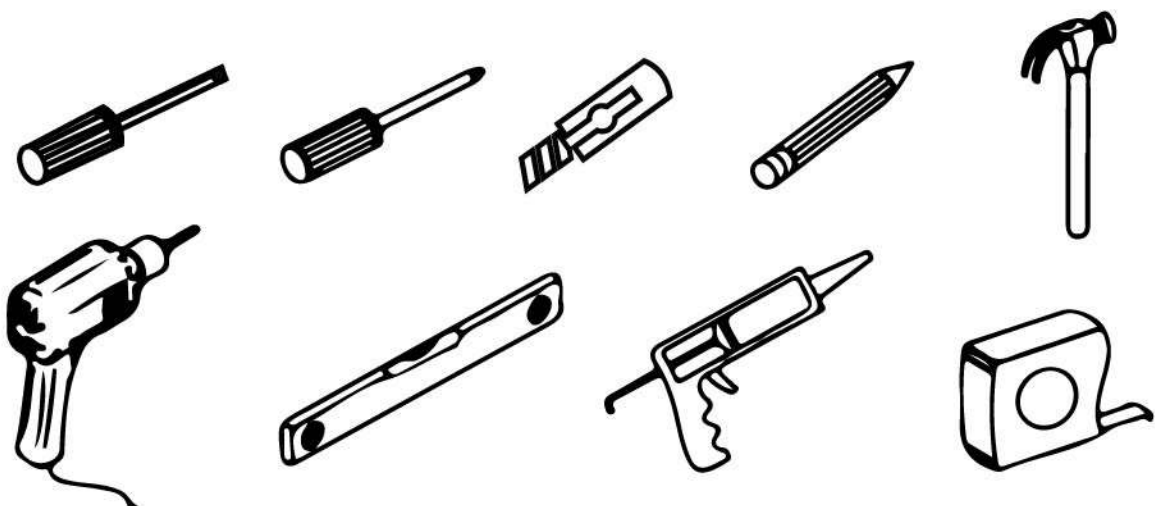





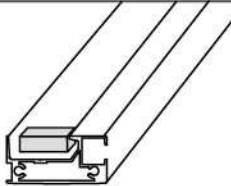

Many household cleaners contain abrasive and chemical substances and should not be used for cleaning painted, plated or plastic fittings. These finished should be cleaned with a mild washing up detergent and wiped dry using a soft cloth. Regular cleansing with a biodegradable cleanser prevents stubborn stains and ensures a clean and hygienic surface for many years. Do NOT use scouring or caustic cleansers under any circumstances. These can damage the surface finish of this product.

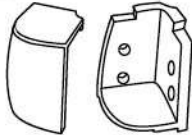
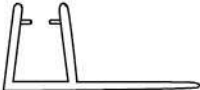
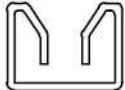

## Tools & Equipments Required

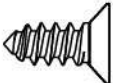

## Parts list

<b>1</b>  x2	<b>2</b>  x2	<b>3</b>  x2	<b>4</b>  x4
<b>Door Panel</b>   <b>Fixed Panel</b>   <b>Wall Channel</b>   <b>Rail</b>			
<b>5</b>  x2	<b>6</b>  x4	<b>7</b>  x4	<b>8</b>  x2
<b>Door handle</b>   <b>Top roller</b>   <b>Bottom roller</b>   <b>Corner Connectors</b>			
<b>9</b>  x2	<b>10</b>  x4	<b>11</b>  x8	<b>12</b>  x1
<b>F shape water seal</b>   <b>U-type sealant strip</b>   <b>Door stopper</b>   <b>Magnetic Door Seal</b>			
<b>13</b>  x6	<b>14</b>  x6	<b>15</b>  x10	<b>16</b>  x4
<b>Wall plugs</b>   <b>ST4 x 30 Screws</b>   <b>ST4 x 10 screws</b>   <b>Screw cover caps</b>			
<b>17</b>  x4	<b>18</b>  x8		
<b>Frame top cover</b>   <b>ST4 x 20 Screws</b>			

1

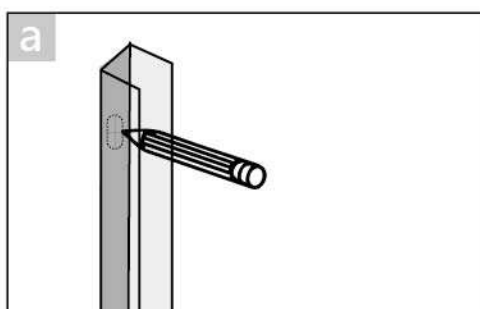
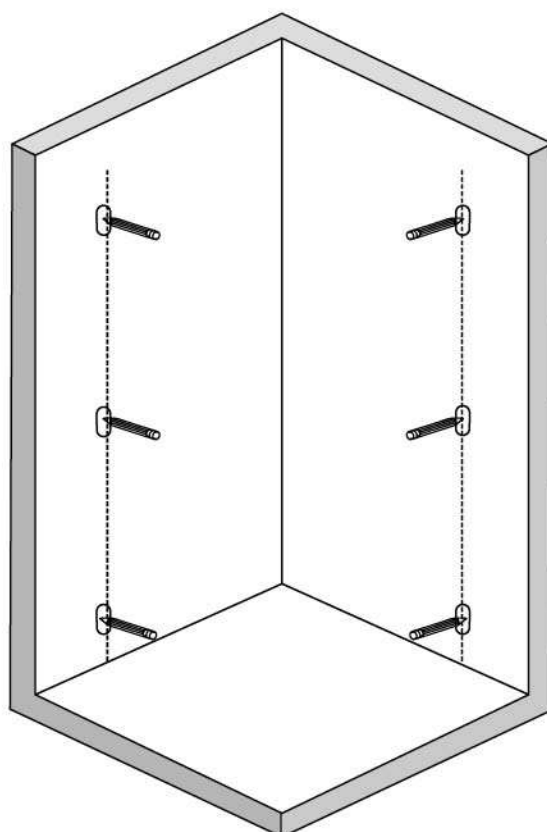

**a** Position and level the wall channels. Mark the fastening holes.

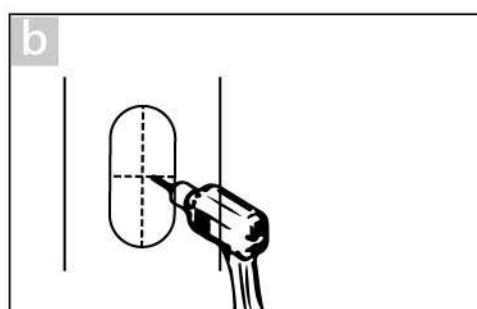

**b** Drill the wall covering.

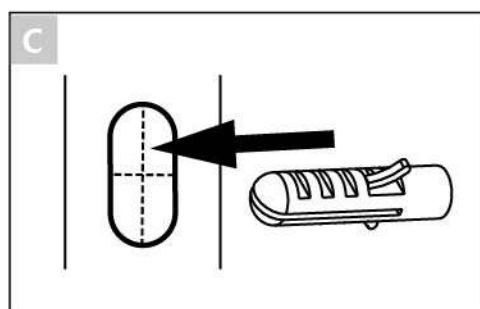

**c** If no studs are behind the wall covering, use wall plugs when fastening the wall channels.

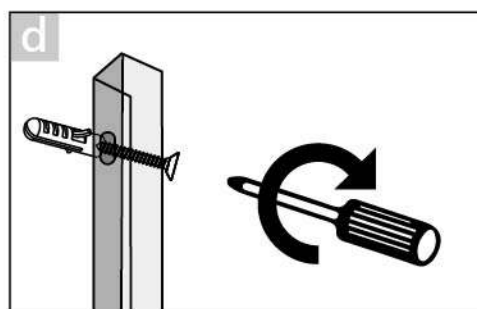

**d** Fasten the wall channel with ST4\*30 screws.

2

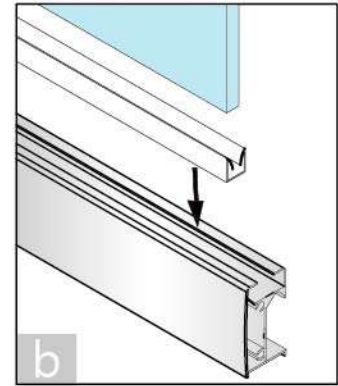
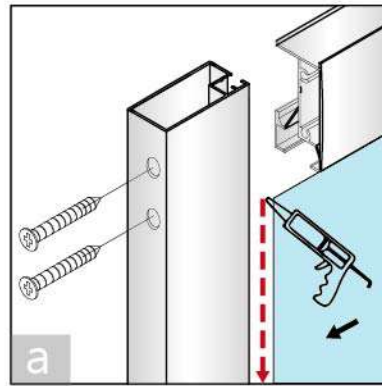
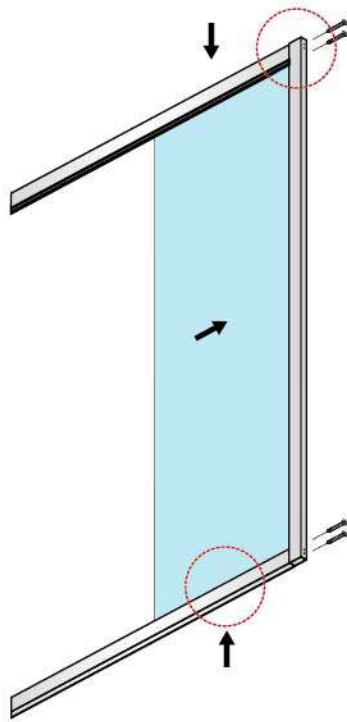

Assemble the top & bottom rails, fixed panel & upright profile together. Silicone upright profile when insert fixed panel.

Insert the fixed panel into top & bottom rails with U-type sealant strip.

3

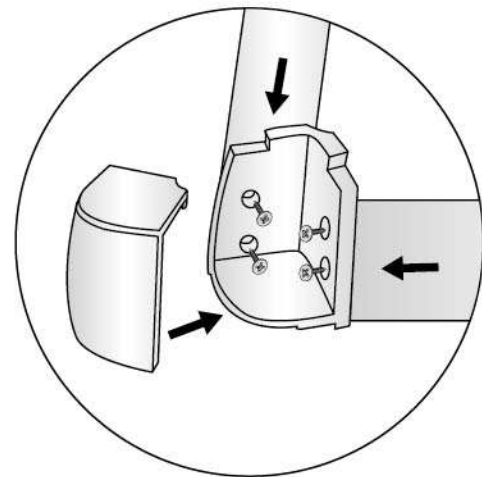
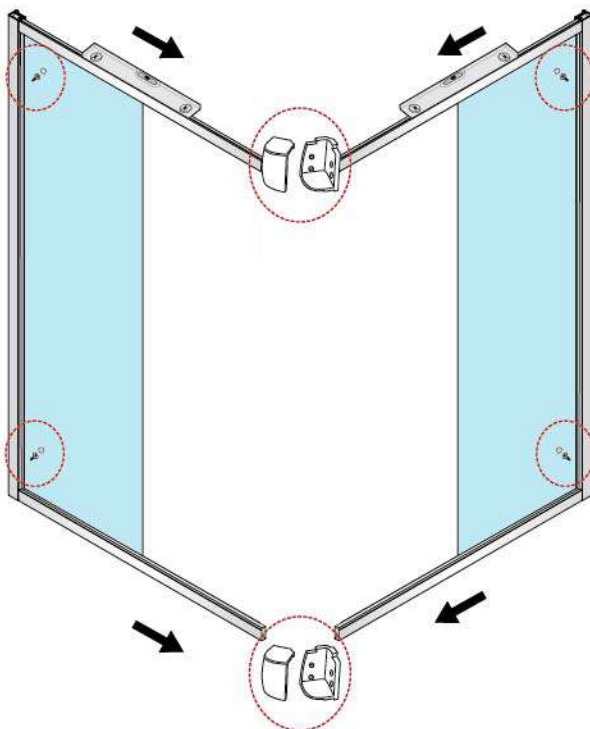

Assemble two frames together with corner connectors by using ST4\*20 screws.

Place whole frame in proper position to make sure it is level.

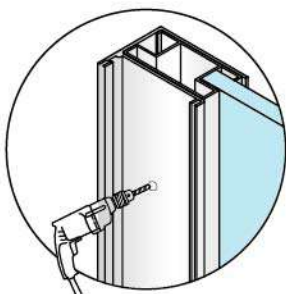

Drill the holes on wall channels.

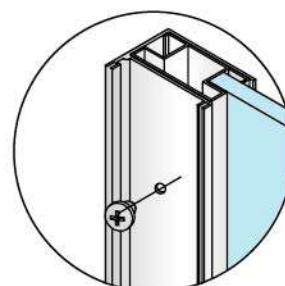

Fasten the wall channels, top and bottom rails with ST4\*10 screws.

4

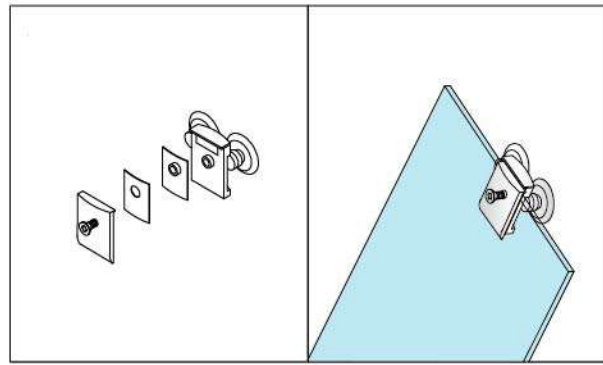
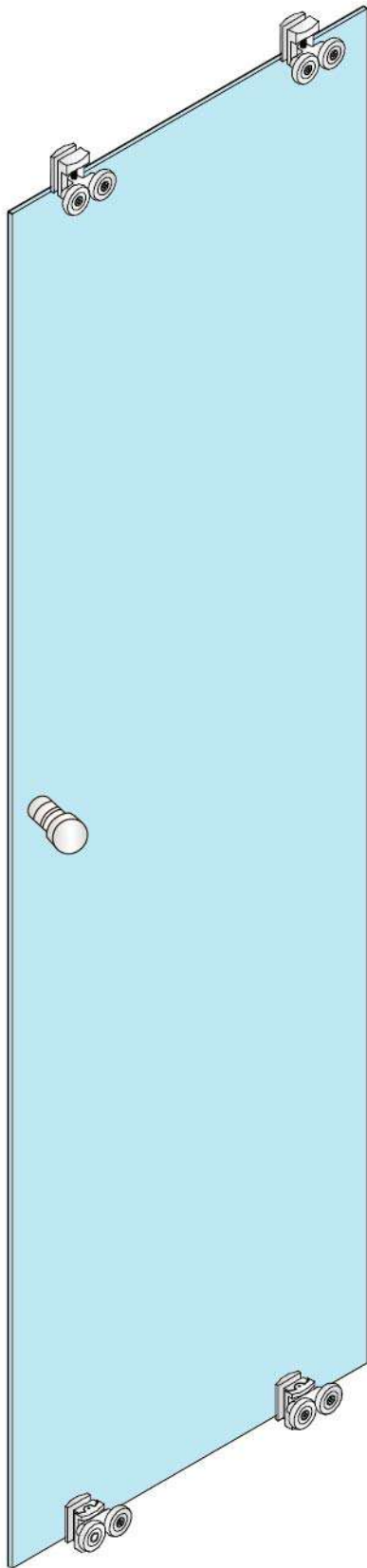

Fit top rollers on the door panel.

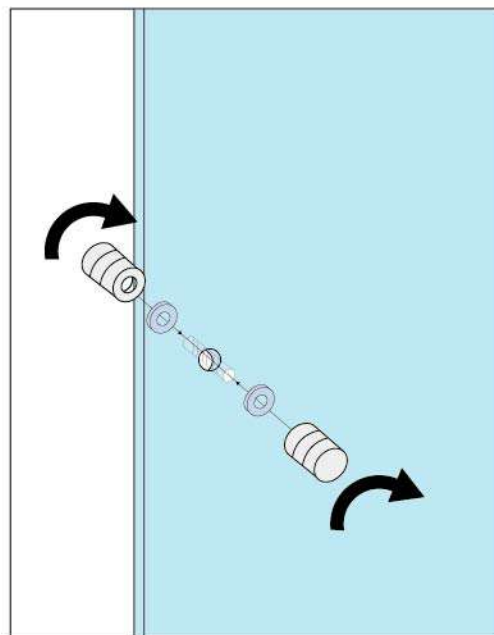

Fit door knob.

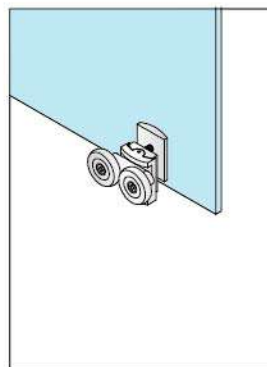

Fit bottom rollers on the door panel.

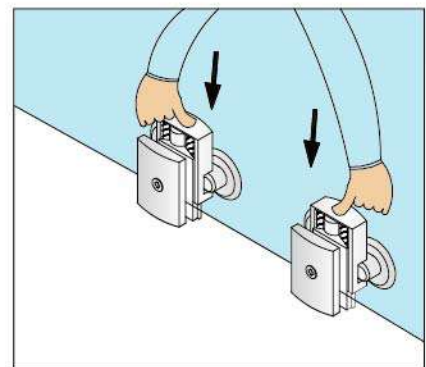

Fit top rollers into the top rail first click bottom rollers on bottom rail by pressing down bottom rollers.

5

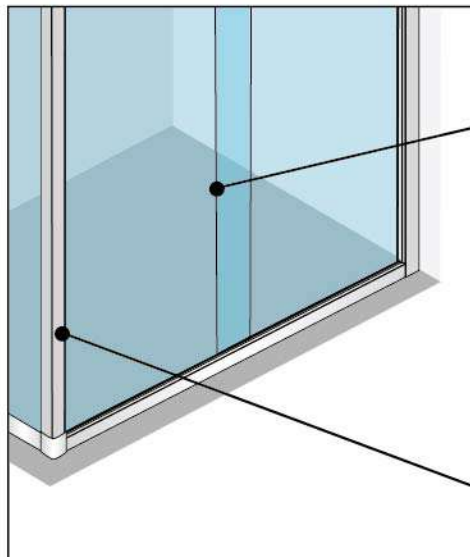

Fit side water seal on door panel.

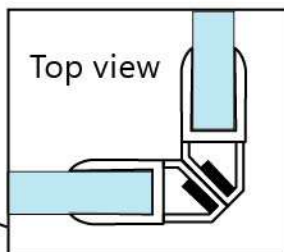
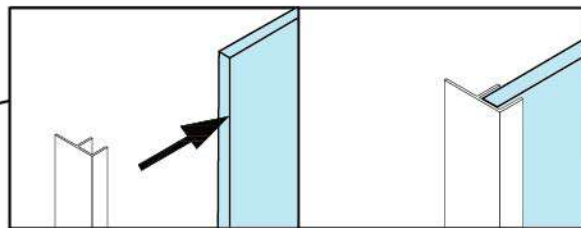

Top view

Fit magnetic door seals on door panels.

6

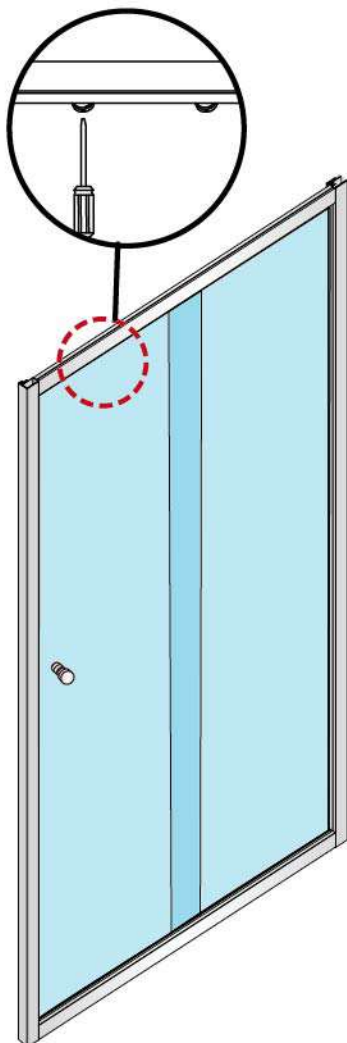

level door panel by adjusting top roller screw to make sure door panel run through smoothly.

7

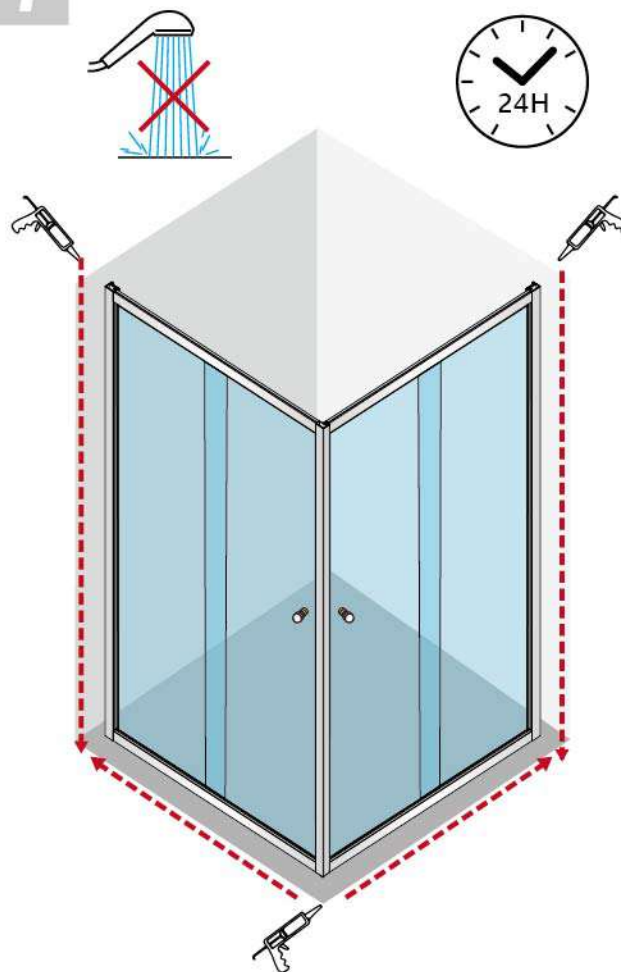

Silicone along wall channel and bottom of the fixed panel. Please allow at least 24 hours for the silicone to fully cure before using the shower.